



Zenit

EN Instructions for use (user) 3

Table of contents

EN

1	Foreword	5
2	Product description	6
2.1	Function	6
2.2	Product overview	6
3	Intended use	10
3.1	Indications for use	10
3.1.1	Special features of the CLT version	10
3.2	Indications	10
3.3	Contraindications	10
3.3.1	Absolute Contraindications	10
3.3.2	Relative Contraindications	10
4	Safety	10
4.1	Explanation of warning symbols	10
4.2	Safety instructions for use	10
4.3	Side effects	14
4.4	Further information	14
4.5	Nameplate and warning labels	14
5	Delivery	15
5.1	Scope of delivery	15
5.2	Options	15
5.3	Storage	15
5.3.1	Storage during daily use	15
5.3.2	Storage during extended disuse	15
6	Preparing the product for use	15
6.1	Assembly	15
7	Use	17
7.1	Further instructions for use	17
7.2	Getting in and transferring	17
7.3	Legrests	18
7.4	Seat cushion and back upholstery	18
7.4.1	Removing and fastening the seat cushion	19
7.4.2	Removing and fastening the back support pad	19
7.5	Backrest	20
7.6	Side panels	20
7.6.1	Adjusting the height of the forearm support	20
7.7	Push handles	21
7.7.1	Adjusting the push handles	21
7.8	Drive wheels	21
7.8.1	Removing and mounting the drive wheels	22
7.9	Caster wheels and caster forks	23
7.9.1	Approach in case of stiffness	23
7.10	Wheel locks	23
7.10.1	Using the wheel locks	23
7.10.2	Using the wheel lock lever extension	24
7.11	Anti-tipper/tip-assist	25
7.11.1	Activating and deactivating the anti-tipper	25
7.11.2	Using the tip-assist	26
7.12	Lap belt (seat belt)	26
7.13	Additional options	27
7.14	Disassembly and transport	27
7.15	Use in vehicles for transporting persons with reduced mobility	29
7.15.1	Zenit, Zenit R without CLT option	29
7.15.1.1	Required accessories	29
7.15.1.2	Installation	30

7.15.1.3	Using the product in a vehicle.....	30
7.15.1.4	Restrictions for use	33
7.15.2	Zenit CLT, Zenit R CLT Option.....	33
7.16	Care.....	33
7.16.1	Cleaning	33
7.16.1.1	Cleaning by hand.....	33
7.16.1.2	Cleaning the seat cushion	34
7.16.1.3	Cleaning belts/straps	34
7.16.2	Disinfection	34
8	Maintenance and repair	35
8.1	Maintenance.....	35
8.1.1	Maintenance intervals	35
8.1.2	Maintenance tasks	35
8.2	Repair	36
8.2.1	Inner tube, rim tape and tyre replacement	36
9	Disposal	37
9.1	Disposal information	37
10	Legal information.....	37
10.1	Liability	37
10.2	Warranty	37
10.3	Service life	37
11	Technical data	38
12	Appendices	39
12.1	Threshold values for wheelchairs transportable by train	39

1 Foreword

INFORMATION

Date of last update: 2020-03-19

- ▶ Please read this document carefully before using the product and observe the safety notices.
- ▶ Obtain instruction from the qualified personnel in the safe use of the product.
- ▶ Please contact the qualified personnel if you have questions about the product or in case of problems.
- ▶ Report each serious incident in connection with the product, in particular a worsening of the state of health, to the manufacturer and to the relevant authority in your country.
- ▶ Please keep this document for your records.

INFORMATION

- ▶ New information regarding product safety and product recalls as well as the declaration of conformity can be obtained at oa@ottobock.com or from the manufacturer's service department (see inside or outside of back cover for addresses).
- ▶ You can request this document as a PDF file at oa@ottobock.com or from the manufacturer's service department (see inside or outside of back cover for addresses). The PDF file can also be displayed in a larger size.

You have received a product that is very versatile for everyday use at home and outdoors.

In order to exclude injuries of any type, familiarise yourself with the handling, functions and intended use of the product before using it. These instructions for use provide you with the related necessary information.

Please note the following in particular:

- All users and/or their attendants must be trained by qualified personnel in the use of the product. In particular, users and/or attendants must be informed of the residual risks with the aid of the safety notices in the instructions for use (user).
- The product was adapted to the needs of the user. Subsequent changes may be made only by qualified personnel. We recommend checking the product settings **once per year** to ensure optimal treatment over the long term. Especially for users with a changing anatomy (for example body dimensions, weight), an adjustment at least **once every six months** is recommended.
- Your product may differ from the models shown. In particular, not all the options described in these instructions for use will be installed on your product.
- The manufacturer reserves the right to make technical changes to the model described in these instructions for use.

2 Product description

2.1 Function

The wheelchair is intended exclusively for transporting one person on the seat.
The wheelchair can be used on solid ground both indoors and outdoors.

2.2 Product overview

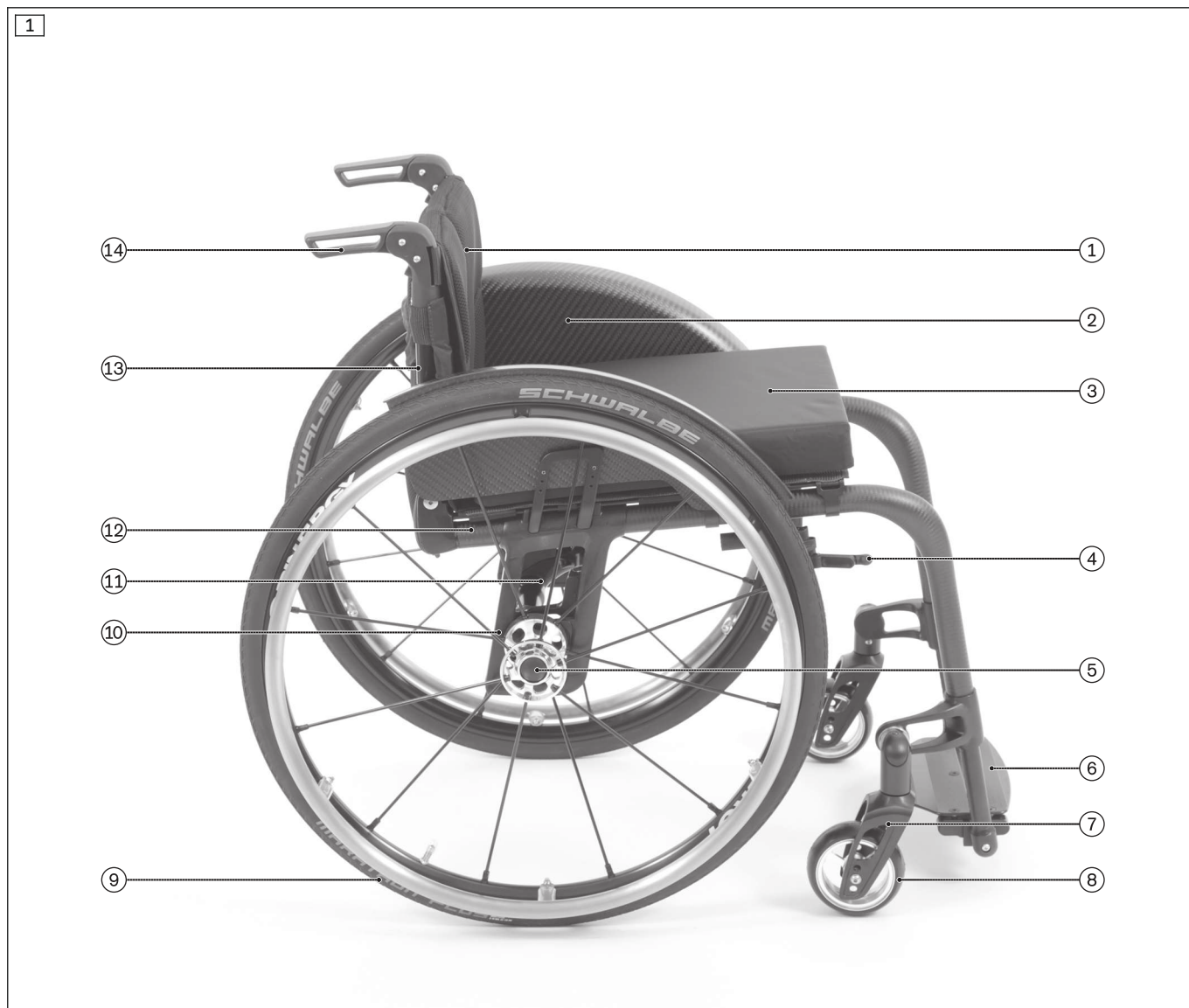

Zenit folding wheelchair

The Zenit folding wheelchair is equipped with an open frame made of aluminium, or optionally of carbon. Thanks to the Easy-Go folding system, it can be unfolded with little effort.

1	Back support/back support upholstery	8	Caster wheel
2	Side panel	9	Drive wheel with handrim
3	Seat/seat pad	10	Adjustable side support with drive wheel attachment device
4	Scissor wheel lock	11	Folding mechanism
5	Release button for quick-release axle	12	Frame
6	Leg support, automatically folding	13	Back support tube
7	Caster fork	14	Push handle

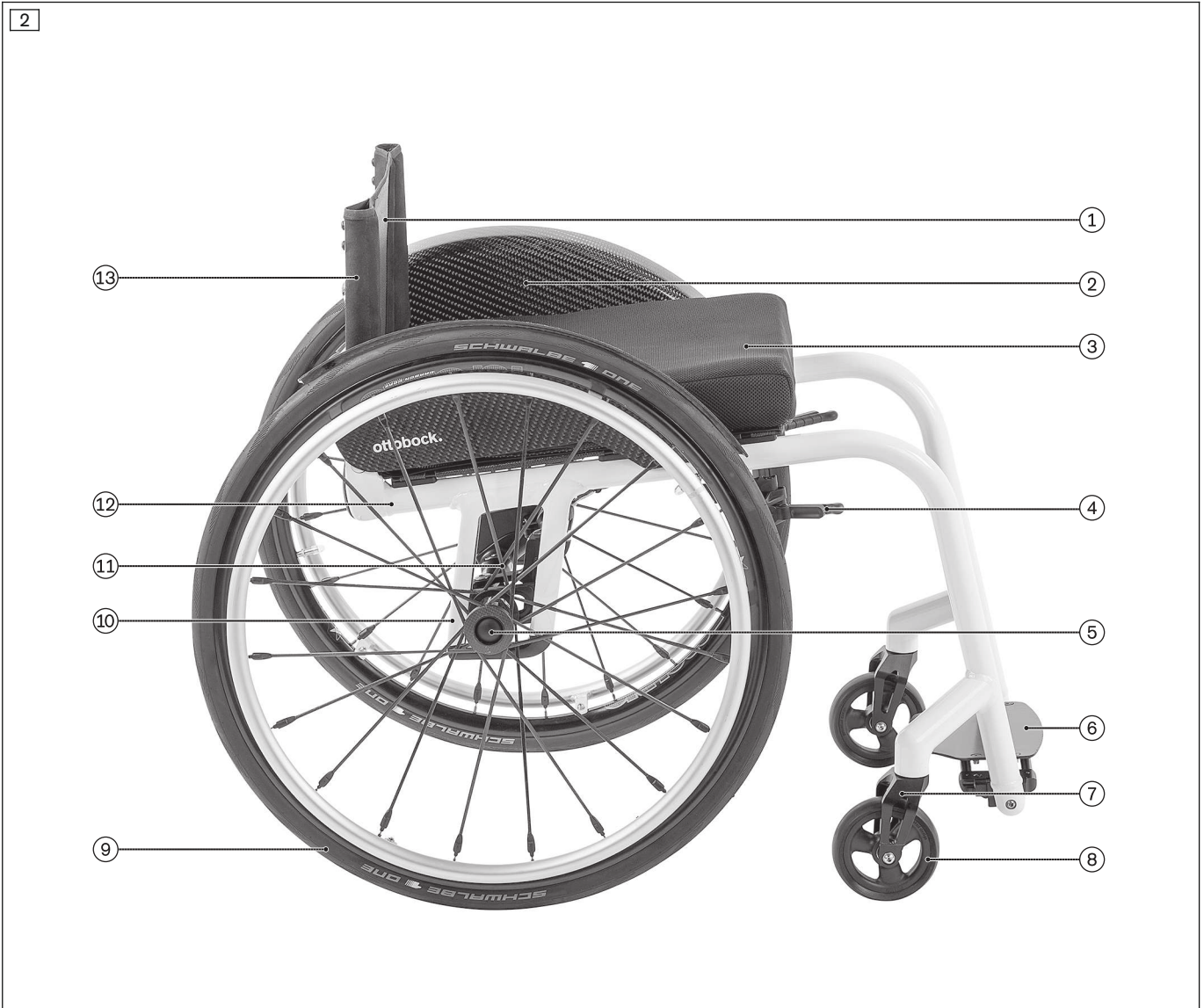

Zenit CLT folding wheelchair

The Zenit CLT folding wheelchair is equipped with an open frame made of aluminium. Thanks to the Easy-Go folding system, it can be unfolded with little effort. The caster fork mountings, side supports with drive wheel attachment devices, wheel lock mountings and back support connection are permanently welded.

1	Back support/back support upholstery	8	Caster wheel
2	Side panel	9	Drive wheel with handrim
3	Seat/seat pad	10	Welded side support with drive wheel attachment device
4	Scissor wheel lock	11	Folding mechanism
5	Release button for quick-release axle	12	Frame
6	Leg support, automatically folding	13	Back support tube
7	Caster fork		

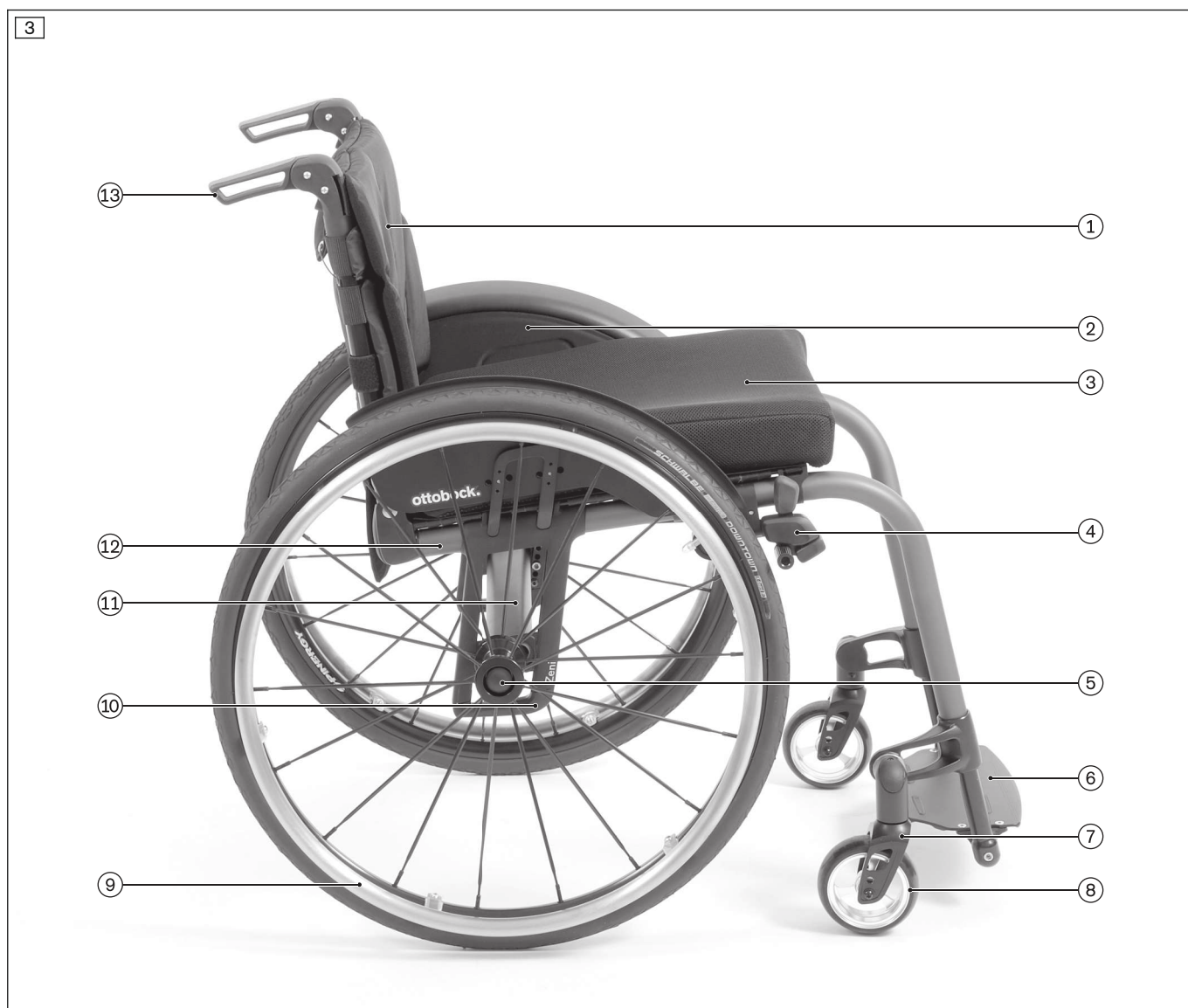

Zenit R rigid frame wheelchair

The Zenit R rigid frame wheelchair is equipped with a frame made of aluminium, or optionally of carbon. The rigid frame wheelchair version with rigid axle and fixed leg support provides a frame geometry that is particularly resistant to warping, for sporty driving characteristics with high torsional stiffness.

1	Back support/back support upholstery	8	Caster wheel
2	Side panel	9	Drive wheel with handrim
3	Seat/seat pad	10	Adjustable side support with drive wheel attachment device
4	Knee lever wheel lock	11	Rigid axle tube
5	Release button for quick-release axle	12	Frame
6	Leg support, fixed installation	13	Push handle
7	Caster fork		

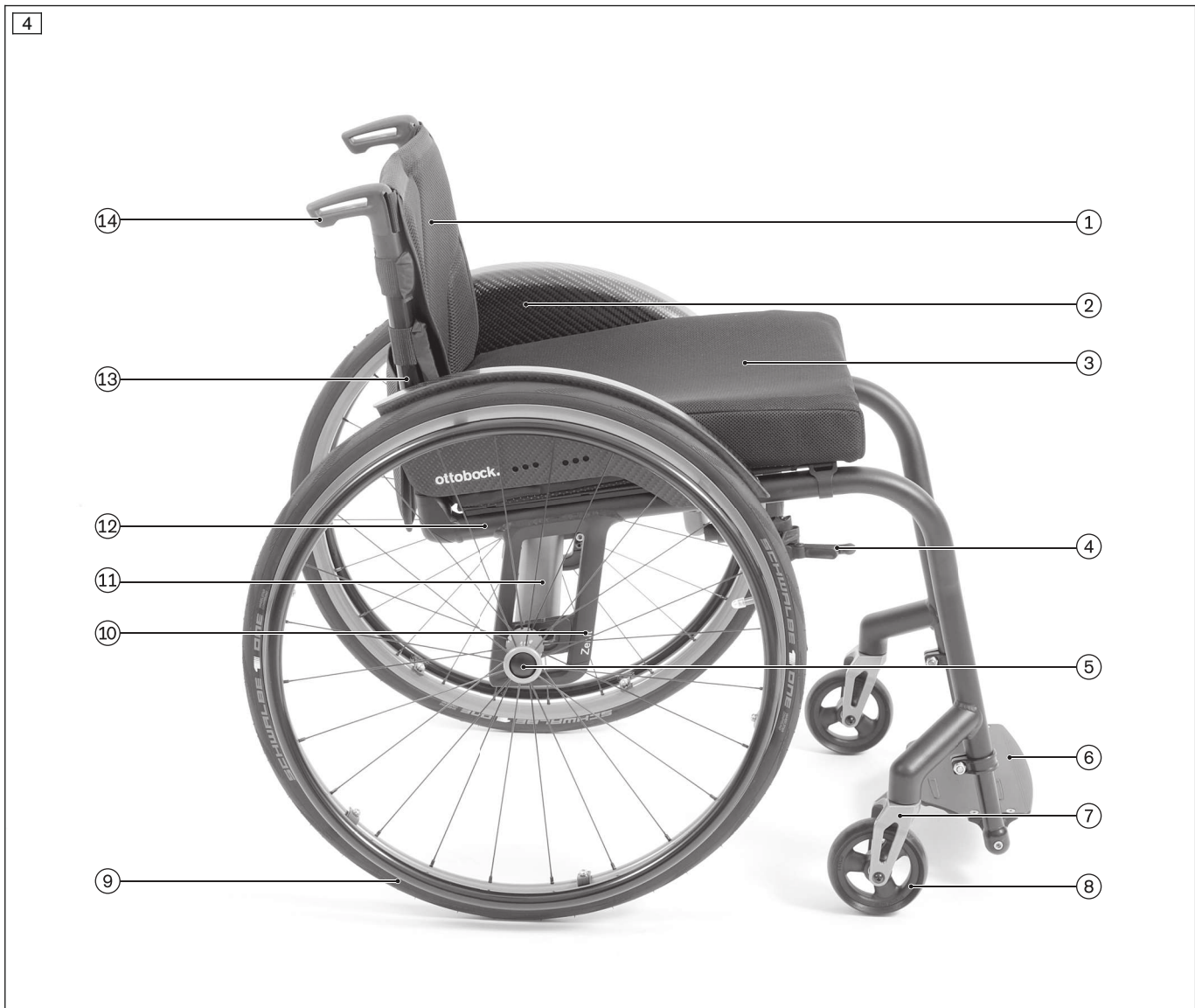

Zenit R CLT rigid frame wheelchair

The Zenit R CLT rigid frame wheelchair is equipped with a frame made of aluminium. The rigid frame wheelchair with rigid axle and fixed leg support provides a frame geometry that is particularly resistant to warping, for sporty driving characteristics with high torsional stiffness. The caster fork mountings, side supports with drive wheel attachment devices, wheel lock mountings and back support connection are permanently welded.

1	Back support/back support upholstery	8	Caster wheel
2	Side panel	9	Drive wheel with handrim
3	Seat/seat pad	10	Welded side support with drive wheel attachment device
4	Scissor wheel lock	11	Rigid axle tube
5	Release button for quick-release axle	12	Frame
6	Leg support, fixed installation	13	Back support tube
7	Caster fork	14	Push handle

3 Intended use

The safe use of the product can only be ensured in case of intended use in accordance with the information contained in these instructions for use. The user is ultimately responsible for accident-free operation.

3.1 Indications for use

The wheelchair is intended for everyday indoor and outdoor use, by the user or an attendant, of people with temporary or permanent limitations of the ability to walk, inability to walk or difficulty standing up.

The product is suitable for users with intact skin whose anatomy (such as body dimensions and weight) permits the intended use of the product.

The wheelchair may only be used with the options listed on the product order form.

Ottobock assumes no liability for combinations with medical devices and/or accessories from other manufacturers outside the modular system.

Combinations based on a combination agreement that have been evaluated for effectiveness and safety are an exception to this.

3.1.1 Special features of the CLT version

In the CLT version, the wheelchair features permanently welded side supports for mounting the drive wheel attachment devices, a permanently welded back support and permanently welded caster attachment devices. In this weight-saving version, the back support height and back support angle, for example, cannot be subsequently adjusted. Furthermore, installation of certain options is not possible with this version.

For these reasons, this wheelchair version is intended only for experienced users with sporting ambitions who, thanks to their physiological capabilities, are able to handle the wheelchair proficiently. Before fitting with this version, the user should be examined intensively for suitability (adequate physiological capabilities).

3.2 Indications

- Minor to pronounced or complete restrictions of mobility

3.3 Contraindications

3.3.1 Absolute Contraindications



- None known

3.3.2 Relative Contraindications

- Failure to meet physical or mental requirements

4 Safety

4.1 Explanation of warning symbols

 WARNING	Warning regarding possible serious risks of accident or injury.
 CAUTION	Warning regarding possible risks of accident or injury.
 NOTICE	Warning regarding possible technical damage.

4.2 Safety instructions for use

Hazards during preparation for use

<p> WARNING</p> <p>Independent modification of settings</p> <p>Serious injuries to the user due to improper changes to the product</p> <ul style="list-style-type: none"> ▶ Do not modify the settings established by the qualified personnel. Only the settings described in the section "Use" in these instructions for use may be adjusted independently. ▶ In case of problems with the settings, please contact the qualified personnel who adjusted your product.
--

⚠ WARNING**Settings outside the safety limits**

Tipping over, falling due to adjustment errors because of failure to observe the physical/psychological requirements of the user

- ▶ In certain versions and with certain settings, the product tends to tip backwards due to its design. This is an intentional feature designed to enable users with the corresponding physical prerequisites to manoeuvre quickly and nimbly.
- ▶ Users with the necessary physical and psychological preconditions can be supplied with such versions/settings. If the physical/psychological preconditions change, the product may no longer be used with these settings. Inform the responsible qualified personnel immediately in this case.

⚠ WARNING**Improper handling of packaging materials**

Risk of suffocation due to neglect of the duty to supervise

- ▶ Packaging materials must be kept out of the reach of children.

Risk of hand injuries**⚠ CAUTION****Pinching on components**

Pinching, crushing due to lack of caution in danger areas

- ▶ Do not reach between the drive wheel and wheel lock or drive wheel and side panel when driving the wheelchair.
- ▶ Do not reach into the spokes of the rotating drive wheel.
- ▶ Pay attention not to pinch parts of your body at the wheel lock lever or between the side or frame parts.

⚠ CAUTION**Heat development when braking with handrims**

Burns due to insufficient hand protection

- ▶ Wear wheelchair gloves when travelling at high speeds.

Hazards while driving**⚠ WARNING****Improper use of the wheel lock**

Falling due to abrupt braking, rolling away of the wheelchair, damage to the wheel lock

- ▶ Do not use the wheel lock as a driving brake.
- ▶ Apply the wheel lock to prevent the wheelchair from moving on uneven ground or during transfers (e.g. into a car).

⚠ CAUTION**Lack of driving experience**

Tipping over, falling due to errors in handling the product

- ▶ Practise on level, open ground first.
- ▶ Learn with the support of an assistant how the product reacts to changes in centre of gravity, e.g. downward or upward slopes, inclines or when overcoming obstacles.

⚠ CAUTION**Leaning forward in the wheelchair**

Tipping over, overturning due to incorrect centre of gravity

- ▶ Do not lean too far out of the wheelchair when trying to pick up objects.
- ▶ Lean well forward with your upper body when climbing gradients, overcoming obstacles on gradients or on ramps. If users cannot lean their upper body forward, accompanying persons must support the wheelchair from behind.

⚠ CAUTION

Risky operation

Falling, tipping over backwards due to approaching obstacles incorrectly

- ▶ Push slowly when crossing obstacles (e.g. steps, curbs) and negotiating uphill or downhill slopes and inclines.
- ▶ Never cross obstacles at an angle. Always approach obstacles head on (at an angle of 90°).
- ▶ Raise the front wheels before crossing obstacles.
- ▶ Avoid collisions with obstacles and dropping off curbs/ledges.
- ▶ Avoid riding cross-country.

⚠ CAUTION

Lack of tipping resistance on public transport

Tipping over, user falls, damage to the product due to incorrect positioning

- ▶ When using public transit, always observe the currently applicable legal requirements and the safety notices of the public transit operator.
- ▶ Use the permanently installed seats in the vehicle. If you depend on using your wheelchair as a seat, please use the designated wheelchair spaces and safety securing equipment provided. Always ensure that you are held in place securely.

⚠ CAUTION

Incorrect handling at level crossings

User may fall or tip over due to driving error

- ▶ Only cross railway systems and railway tracks in the designated areas.
- ▶ Negotiate level crossings so the caster wheels of the product cannot get caught in the gap between the rail and the road surface.

⚠ CAUTION

Driving in the dark

Risk of collisions with other traffic participants due to lack of lighting

- ▶ Wear bright clothing or clothing with reflectors.
- ▶ Install active lighting on your product.
- ▶ Ensure that the reflectors on the product are clearly visible.

Hazards when overcoming obstacles

⚠ WARNING

Overcoming steps and obstacles without assistance

Tipping over, falling of the user due to failure to observe transportation instructions

- ▶ Always have accompanying persons help you negotiate steps and other obstacles.
- ▶ Use available facilities (e.g. access ramps or lifts).
- ▶ If such facilities are not available, have 2 assistants carry you over the obstacle.

⚠ WARNING

Improper lifting by attendants

Tipping over, falling of the user due to lifting by removable components

- ▶ Only lift the product by firmly mounted components (e.g. main frame, push handles).
- ▶ Be sure that the clamping levers of the height-adjustable push handles are firmly tightened.

Hazard in case of broken skin

CAUTION

Skin damage

Skin damage or pressure points due to overloading

- ▶ Check your skin for intactness before and during use of the product.
- ▶ Pay attention to diligent skin care and pressure redistribution during interruptions in using the product.
- ▶ If skin damage or other problems occur during use, stop using the product. Consult the qualified personnel.

Hazards due to fire, heat and cold

CAUTION

Extreme temperatures

Hypothermia or burns due to contact with components, failure of components

- ▶ Do not expose the product to any extreme temperatures (e.g. direct sunlight, sauna, extreme cold).
- ▶ Do not leave the product in the immediate vicinity of heaters.

Hazards due to improper use of the product

WARNING

Overloading

Severe injuries if the product tips over due to overloading, damage to the product

- ▶ Do not exceed the maximum load capacity (see the nameplate and section "Technical data").
- ▶ Please note that certain accessories and add-on components will reduce the remaining load capacity.

WARNING

Exceeding the service life

Serious injuries due to failure to observe the manufacturer's requirements

- ▶ Using the product beyond the specified expected service life leads to increased residual risk.
- ▶ Observe the specified service life.

WARNING

Incorrect pushing or pulling of the wheelchair

Risk of falling, tipping over due to user error

- ▶ Only the push handles may be used for pushing or overcoming obstacles. The tip-assist should be used in addition.
- ▶ If a stabiliser bar is installed, it must **not** be used for pulling or pushing.
- ▶ The attendant should make sure that he/she has a secure stance and firm grip (on both sides).
- ▶ In case of damage, have the push handles repaired promptly.

CAUTION

Use of the product during diagnostic examinations and therapeutic treatment

Impairment of the examination results or the effectiveness of treatment due to interactions of the product with devices that are used

- ▶ Make sure that examinations and treatments are carried out exclusively under the prescribed conditions.

CAUTION

Uncontrolled driving behaviour, unexpected sounds or odours

Falling, tipping, collision with persons or nearby objects due to defects

- ▶ If any faults, defects or other hazards that can lead to personal injury are detected, the product must be taken out of service immediately. This includes uncontrolled movements as well as sounds that are unexpected or previously not noted or odours that deviate significantly from the state of the product at the time of delivery.
- ▶ Contact the qualified personnel.

NOTICE

Use under incorrect environmental conditions

Damage to product due to corrosion or abrasion

- ▶ Do not use the product in salt water.
- ▶ Make sure that the wheel bearings are not damaged by sand or other particles.

4.3 Side effects

The following side effects may occur during use of the product:

- Neck, muscle and joint pain
- Circulatory disorders, risk of pressure sores

Contact a doctor or therapist in case of problems.

4.4 Further information

INFORMATION

Even in the event of compliance with all applicable guidelines and standards, alarm systems (e.g. in department stores) may respond to your product. Should this happen, remove your product from the area where the alarm was triggered.

INFORMATION

The serial number required for enquiries and orders can be found on the nameplate. For explanations of the nameplate, see the section "Nameplate" (Nameplate).

4.5 Nameplate and warning labels

The nameplates are found on the frame.

Label	Meaning
	A Manufacturer's product name
	B CE marking
	C Maximum load (see section "Technical data")
	D Manufacturer information/address
	E Serial number ¹⁾
	F Manufacturing date ²⁾
	G Symbol for medical device
	H WARNING! Read the instructions for use before using the product. Observe important safety-related information (e.g. warnings, precautions).
	I Manufacturer's reference number for the product variant
	J Serial number (PI) ^{3),1)}
K Global Trade Item Number (DI) ⁴⁾	

1) YYYY = year of manufacture; WW = week of manufacture; PP = production site; XXXX = sequential production number
 2) YYYY = year of manufacture; MM = month of manufacture; DD = day of manufacture
 3) UDI-PI to GS1 standard; UDI = Unique Device Identifier, PI = Product Identifier
 4) UDI-DI to GS1 standard; UDI = Unique Device Identifier, DI = Device Identifier

Label	Meaning
	Fixation point to attach the product in vehicles for transporting persons with reduced mobility

Label	Meaning
	Risk of pinching. Do not reach into the danger area.

5 Delivery

5.1 Scope of delivery

- Wheelchair ready for use
- Instructions for use (user)
- Instructions for use for accessories (depending on equipment)

5.2 Options

The standard model can be fitted to the user's personal requirements thanks to a large range of options. For use of these options: see Page 17 ff.

5.3 Storage

5.3.1 Storage during daily use

The product should always be stored so it is protected against external influences.

5.3.2 Storage during extended disuse

The product must be stored in a dry place. Specific information for extended storage: see Page 38.

It is not necessary to disassemble the product.

Maintain sufficient clearance from sources of heat. If the product is parked for an extended period of time or the tyres overheat (e.g. in the vicinity of radiators or in case of exposure to strong sunlight behind glass), the tyres may become permanently deformed.

During extended storage, the knee lever wheel lock on wheelchairs with PU tyres (= tubeless tyres) must be released since tyre deformation may otherwise result.

6 Preparing the product for use

6.1 Assembly

⚠ CAUTION

Exposed pinch points

Crushing, pinching due to incorrect handling

- ▶ When folding the wheelchair out or together, only grip by the specified components.

⚠ CAUTION

Failure to verify readiness for use before putting into operation

Tipping, falling due to incorrect adjustment or installation

- ▶ Before you start using the wheelchair for the first time, check the chosen wheelchair settings with the support of qualified personnel.
- ▶ After every assembly, check for proper mounting of the drive wheels. The quick-release axles must be securely locked in the receiver bushings.
- ▶ Pay particular attention to the stability against tipping, free running of the drive wheels and correct function of the wheel locks.
- ▶ Check the tyre pressure. The correct tyre pressure is printed on the sidewall. Ensure that the pressure is the same in both tyres.

INFORMATION

The assembly described below may also be carried out the same way on the CLT model (not illustrated). The "Folding back support" option is not offered for the Zenit CLT.

INFORMATION

On the topic of disassembly/transport: see Page 27.

It only takes a few simple steps to prepare the wheelchair (see fig. 5) for use:

Zenit; Zenit CLT – folding version

- 1) **Only if necessary:** Attach the drive wheels to the quick-release axle mounting (see fig. 6). The quick-release axles must not be removable after releasing the push-button.
- 2) Unfold the wheelchair by pulling the drive wheel to the side (see fig. 7). Ensure that the folding mechanism is fully unfolded. Hearing the folding mechanism engage audibly indicates that the folding process is complete.
- 3) **Only with “Folding back support” option:** Pull the release strap for the folding mechanism of the back support in the direction of travel of the wheelchair and fold the back support up (see fig. 8). In doing so, ensure that both back support tubes engage in the upright position (see fig. 9).
Only with “Leg support with unlocking” option: Firmly press down the foot plate until the locking mechanism engages (see Page 18).
- 4) If necessary, fold the push handles up (see fig. 10).
- 5) Fit the seat cushion. The seat cushion is secured against sliding by being pressed onto the hook-and-loop closure.





Zenit R; Zenit R CLT – rigid frame version

- 1) **Only if necessary:** Attach the drive wheels to the quick-release axle mounting (see illustration above). The quick-release axles must not be removable after releasing the push-button.
- 2) **Only with “Folding back support” option:** Pull the release strap for the folding mechanism of the back support in the direction of travel of the wheelchair and fold the back support up (see illustration above). In doing so, ensure that both back support tubes engage in the upright position (see illustration above).
- 3) If necessary, fold the push handles up (see illustration above).
- 4) Fit the seat cushion. The seat cushion is secured against sliding by being pressed onto the hook-and-loop closure.

7 Use

7.1 Further instructions for use

- Attaching loads (e.g. backpacks) can adversely affect stability. Therefore, suspending additional loads on the wheelchair is not permitted.
- The recommended overall width for manual wheelchairs in an operational state is **700 mm**. This specification should ensure unhindered use of escape routes, for example. Please note that the product dimensions can exceed the recommended value in versions with very large seat widths (for more information see see Page 38 ff.).
- The wheelchairs in this series fully satisfy the minimum technical requirements for wheelchairs transportable by train. However, please note that it is possible that not every individual wheelchair will fulfil the minimum requirements due to the variation in designs (please see see Page 39 for further details).

7.2 Getting in and transferring

⚠ CAUTION

Incorrect handling when getting in

Risk of falling, tipping or rolling away due to incorrect handling

- ▶ Activate the wheel lock each time before you get into or out of or transfer to or from the wheelchair.
- ▶ Always get into the wheelchair from the side, where possible.
- ▶ Never step on the foot plates when getting in and out.
- ▶ Do not support yourself on the wheel lock when getting in/out.

Users can choose the method for getting into and out of the wheelchair which is most suitable for them. The respective procedure should be discussed and practised with a therapist.

As a rule, the frame tubes, seat bottom or side panels can be used as supports for getting into the wheelchair.

If getting in independently is not possible, transferring or getting in always has to be performed with the help of an assistant. The manufacturer also offers transfer aids for getting in, such as transfer boards.

7.3 Legrests

⚠ CAUTION

Improper use of the legrests

Tipping over, falling due to errors in handling the product

- ▶ Fold up the footplates before getting in.

The purpose of the leg supports is to support the legs of the user (Zenit folding wheelchair: see fig. 11; Zenit CLT folding wheelchair: see fig. 12).

One version of the leg support is equipped with an unlocking and locking mechanism (see fig. 13). The foot plate can be folded up after the release button is pressed (see fig. 14). To lock it, firmly press down the foot plate until the locking mechanism engages again.

The height of the leg support has been adjusted by qualified personnel to the length of the user's lower legs.

The angle of the foot support has been set by the qualified personnel so that it allows the ankles to rest in a comfortable position.

The depth of the foot plate is **140 mm**.

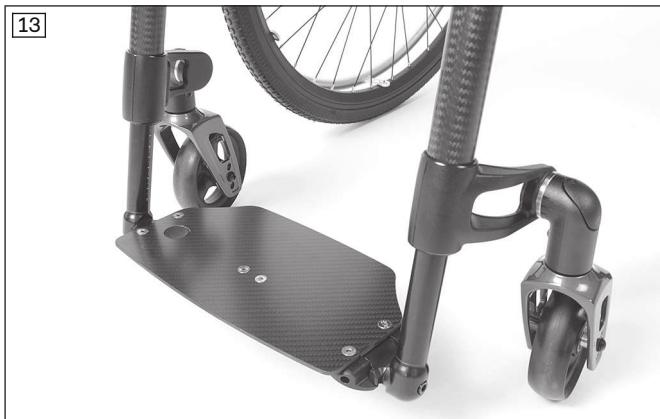

7.4 Seat cushion and back upholstery

⚠ WARNING

Seat cushions and back support pads may ignite

Burns due to user error

- ▶ The seat and back support upholstery as well as seat cushions, padding and covers fulfil the normative requirements for flame resistance. However, they may still ignite if fire is handled improperly or negligently.
- ▶ Keep away from all ignition sources, especially lit cigarettes.

⚠ CAUTION

Wear of the seat and back upholstery

Loss of functionality due to prohibited continued use

- ▶ Have the seat and back upholstery replaced immediately in case of damage.

The product is equipped with seat and back upholstery. Hook-and-loop fasteners on the seat upholstery are used to attach the seat cushion. The seat cushion ensures pressure relief during use of the wheelchair. It was chosen by qualified personnel according to the needs of the user.

7.4.1 Removing and fastening the seat cushion

The seat cushion can be removed from the wheelchair for cleaning.

- 1) Lay the seat cushion onto the seat upholstery and secure it against sliding by pressing it onto the hook-and-loop fastener (see fig. 15).
- 2) To remove, detach the seat cushion from the hook-and-loop closure on the seat upholstery.



7.4.2 Removing and fastening the back support pad

The back padding can be removed from the wheelchair for cleaning.

Removing the back support pad

- 1) Remove the seat cushion.
- 2) Pull the back support pad off the seat upholstery towards the rear (see fig. 16).
- 3) Pull the back support pad off the hook-and-loop straps of the back support upholstery (see fig. 17).

Fastening the back support pad

- 1) From the rear, apply the edge of the back support pad to the upper hook-and-loop strap (see fig. 18).
- 2) Fold down the back support pad and secure it to the upholstery straps with the hook-and-loop fasteners (see fig. 19).
- 3) Pull the part of the flap that can be fastened forward and attach it to the seat upholstery with the hook-and-loop fastener.



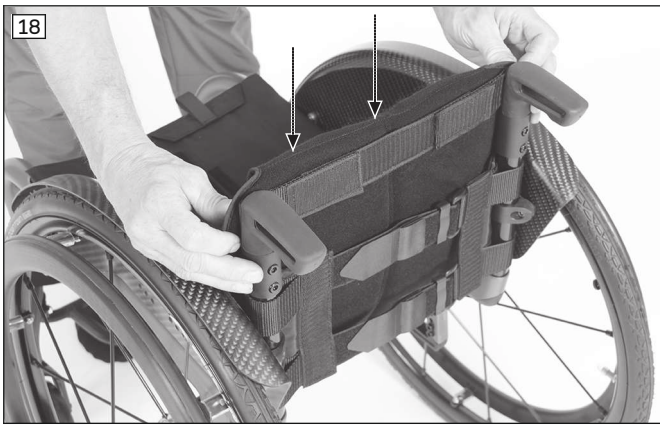

7.5 Backrest

The product can be equipped with a fixed or optionally an angle-adjustable backrest.

“Angle-adjustable back support, folding” option

With this option, the back support angle is adjustable and the back support can be laid down onto the seat bottom.

- 1) Pull the strap of the back support release mechanism until the adjustment mechanism is released (see fig. 20).
- 2) Move the back support to the desired position.
- 3) Release the strap.



7.6 Side panels

⚠ CAUTION

Pinching at the side panels

Pinching, crushing due to lack of caution in danger areas

- ▶ Pay attention not to pinch parts of your body between the side panel or frame parts.

The side panels protect the user and his/her clothing from getting dirty.

If armrests have been installed on the wheelchair, they offer the user additional support for the forearms.

7.6.1 Adjusting the height of the forearm support

With the “Side panel with arm pad” option, the height of the forearm support can be set to various positions without the use of tools.

- 1) Press in the push-button on the inner side of the side panel (see fig. 21, item 1).
- 2) Bring the forearm support to the desired position.
- 3) Release the push-button. The forearm support locks into place automatically.



7.7 Push handles

The push handles make pushing the wheelchair easier for the attendant.

Some of the push handle designs allow the height to be adjusted to suit the needs of the attendant.

7.7.1 Adjusting the push handles

If the "height-adjustable push handle" option is used, the push handles can be adjusted in order to make pushing easier for the attendant.

- 1) Release the clamping lever.
 - 2) Adjust the height of the push handle.
 - 3) Lock the clamping lever securely.
- Both push handles must be adjusted to the same height.

7.8 Drive wheels

⚠ WARNING

Improper assembly of removable wheels

Tipping, falling over of the user due to wheels coming off

- ▶ After each assembly, verify the proper fit of the removable wheels. The quick-release axles must be firmly locked in the wheel attachment.

⚠ WARNING

Defective tyres

Accidents/falling due to poor traction, reduced braking force or lack of manoeuvrability

- ▶ Maintain sufficient tyre pressure. Note the information in the section "Technical data" or on the tyre sidewall.
- ▶ Ensure that the pressure is the same in both tyres.
- ▶ Ensure that the tyres have sufficient tread depth.

⚠ CAUTION

Reaching into exposed drive parts

Crushing, pinching due to incorrect handling

- ▶ Do not reach between the drive wheel and wheel lock or drive wheel and side panel when driving the product.
- ▶ Do not reach into the spokes of the rotating drive wheel while riding in the product.

⚠ CAUTION

Heat development when braking with handrims

Burns due to insufficient hand protection

- ▶ Wear wheelchair gloves when travelling at high speeds.

The wheelchair is moved, steered, braked and stopped with the help of the handrims on the drive wheels. To make transport easier, drive wheels with quick-release axle can be taken off the wheelchair.

7.8.1 Removing and mounting the drive wheels

⚠ CAUTION

Incorrect removal/attachment of the wheels

Tipping, falling due to incorrect installation

- ▶ The user is not permitted to sit in the wheelchair during wheel replacement.
- ▶ For changing wheels, set the wheelchair onto a solid surface.
- ▶ To change the wheels, secure the wheelchair against tipping over or rolling away.
- ▶ If the drive wheel does not lock securely or has too much sideways play, contact the qualified personnel promptly.

Rear wheels with quick-release axle

- 1) Release the wheel lock.
- 2) Grip the area between the spokes near the hub with your fingers.
- 3) Use your thumb to press in the push-button on the quick-release axle.
- 4) Remove or mount the drive wheel.

After mounting: The drive wheels must not be removable after releasing the push-button on the quick-release axle.



Drive wheels with lock-release assist

The quick-release axle with lock-release assist for people with quadriplegia makes it possible to install the drive wheels even in case of severely limited mobility of the arms and hands.

- 1) Open the lock-release assist according to the handle position (see fig. 23: locked – handle is parallel to wheel hub; see fig. 24: unlocked – handle is perpendicular to wheel hub). The lock is released when the handle is positioned horizontally (90° position).
- 2) Pull off/push on the drive wheel.
- 3) Close the lock-release assist (see fig. 23: locked – handle is parallel to wheel hub; see fig. 24: unlocked – handle is perpendicular to wheel hub).

INFORMATION: The wheels must fit in to the wheel attachment device without there being any play after closure.

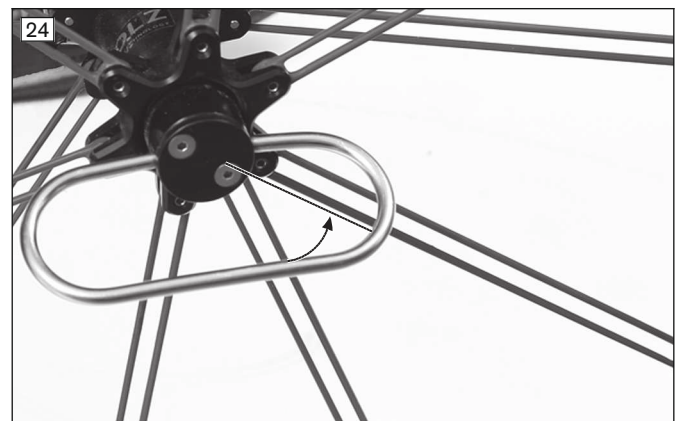

7.9 Caster wheels and caster forks

⚠ WARNING

Failure of caster wheels or caster forks

Falling, severe injury due to the wheelchair tipping over

- ▶ Regularly inspect the caster wheels and caster forks for damage.
- ▶ Regularly clean and oil the caster wheel axles and the threaded axles on the caster forks, especially in case of stiffness.
- ▶ Inform the responsible qualified personnel in case of permanent changes to the driving characteristics.

⚠ CAUTION

Incorrect caster wheel position when leaning forward in the wheelchair

Tipping over, falling due to incorrect caster wheel positioning

- ▶ Prior to activities that require you to bend forward in the wheelchair (e.g. tying your shoes), maximise the stability of the wheelchair.
- ▶ In order to do so, push the wheelchair backwards until the caster wheels turn forward.

The combination of caster wheels and caster forks ensures the ability to hold a straight line and navigate bends securely.

The caster wheels and caster forks have been chosen by the qualified personnel according to the needs of the user.

7.9.1 Approach in case of stiffness

In case of stiffness, the caster wheel axles should be cleaned and oiled.

Oiling the caster axle

- 1) Remove dirt (such as hairs) from the caster axle between the caster wheel and caster fork.
- 2) Lubricate the caster axle between the caster wheel and caster fork with a few drops of thin, resin-free oil (sewing machine oil).

7.10 Wheel locks

The wheel locks secure the parked wheelchair against rolling away.

7.10.1 Using the wheel locks

⚠ WARNING

Improper use of the wheel lock

Falls due to abrupt braking, rolling away of the product, crushing of hands

- ▶ Do not use the wheel lock as a driving brake.
- ▶ Always engage the wheel lock on both sides.
- ▶ Engage the wheel lock to prevent the product from moving when it is parked on uneven ground or during transfers (e.g. into a car).
- ▶ Do not reach between the rear wheel and the wheel lock when driving the product.
- ▶ Ensure that the knee lever wheel lock is properly adjusted (max. **5 mm** gap to the tyre). The lock bolt must lock the drive wheel securely when stationary.
- ▶ Please contact the qualified personnel who adjusted your product for readjustment of the wheel lock.

Activating/deactivating the knee lever wheel lock

- 1) Push the handle of the knee lever wheel lock forward (see fig. 25).
→ The wheel lock bolt secures the wheel.
- 2) Pull the handle of the knee lever wheel lock up (see fig. 26).
→ The wheel lock bolt releases the wheel.



Activating/deactivating the scissor wheel lock

- 1) Reach under the seat and pull the handle of the scissor wheel lock towards the back from the side (see fig. 27).
→ The wheel lock bolt secures the wheel.
- 2) Pull the handle of the scissor wheel lock forwards to unfold (see fig. 28).
→ The wheel lock lever releases the wheel.



7.10.2 Using the wheel lock lever extension

The “plug-on wheel lock lever extension” option makes the knee lever wheel lock easier to use. The wheel lock lever extension can be removed for easier transfer into the wheelchair. The wheel lock lever extension is attached to the wheel lock lever with a rubber band.

Removing/mounting the wheel lock lever extension

- 1) Pull the handle of the wheel lock lever extension forward or up, away from the wheel lock lever (see fig. 29, left).
- 2) Fold the wheel lock lever extension either forward (see fig. 29, right) or to the side (see fig. 30).
- 3) To mount, pull on the handle of the wheel lock lever extension and slide the wheel lock lever extension back onto the wheel lock lever.



7.11 Anti-tipper/tip-assist

⚠ WARNING

Anti-tipper not activated

Tipping over, falling of the user due to improper operation of a safety device

- ▶ Ensure that an installed anti-tipper is activated before travelling over obstacles and on inclines.
- ▶ The anti-tipper has to engage audibly prior to use. Proper engagement must be checked by the user or an attendant.
- ▶ The use of an anti-tipper is highly recommended for transfemoral amputees and inexperienced users.

⚠ WARNING

Incorrectly adjusted anti-tipper

Tipping over, falling of the user due to errors in handling the product

- ▶ If only one attendant helps in overcoming steps, the attendant must first deactivate the anti-tipper so that it cannot collide with the steps during transport.
- ▶ The attendant must activate the anti-tipper again after overcoming the steps.

⚠ WARNING

Incorrectly adjusted anti-tipper

Risk of falling as a result of incorrectly adjusted anti-tipper.

- ▶ The anti-tipper may only be adjusted by qualified personnel.

The anti-tipper prevents the wheelchair from tipping backwards when overcoming obstacles and going uphill. It is set for a maximum ground clearance of **50 mm** and so that the anti-tipper rollers, as a minimum, project fully beyond the largest diameter of the drive wheels.

The tip-assist makes overcoming obstacles easier for the attendant.

7.11.1 Activating and deactivating the anti-tipper

A mounted anti-tipper must always be active.

When overcoming obstacles (such as steps and curbs that are not lowered) **upwards**, the anti-tipper rollers contact the ground.

When overcoming obstacles (such as steps and curbs that are not lowered) **downwards**, the anti-tipper has to be deactivated by the user or attendant to avoid damaging the anti-tipper.

Activation

- 1) Push the anti-tipper down with the hand or foot (see fig. 31, item 1; see fig. 32, item 1).
- 2) Swing the anti-tipper back by **180°** and allow it to engage (see fig. 31, item 2; see fig. 32, item 2).

Deactivation

- 1) From above, press on the anti-tipper with the hand or foot until it disengages (see fig. 33, item 1; see fig. 34, item 1).
- 2) Rotate the anti-tipper forward by **180°** and release it (see fig. 33, Pos. 2; see fig. 34, Pos. 2).

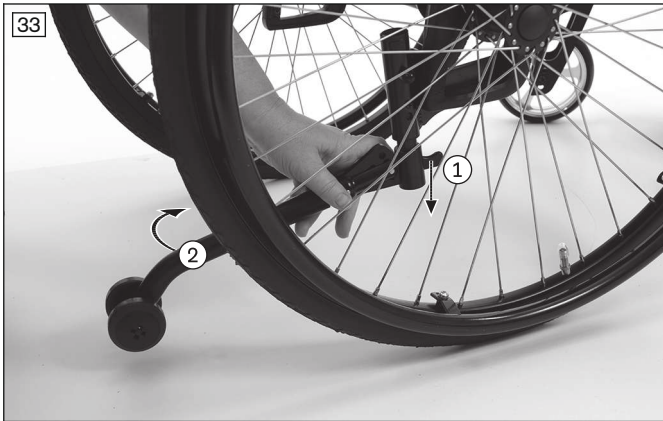
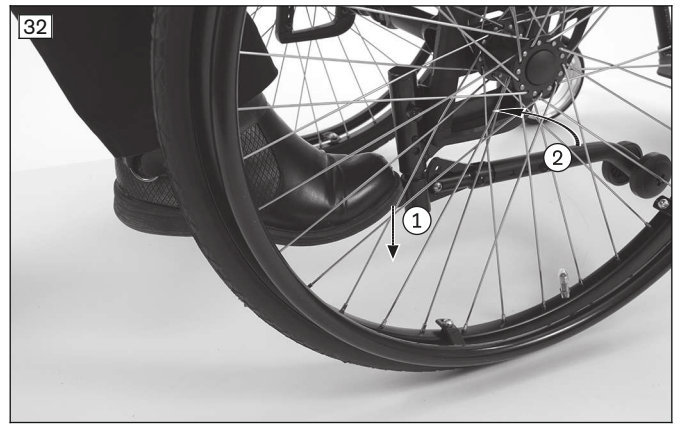
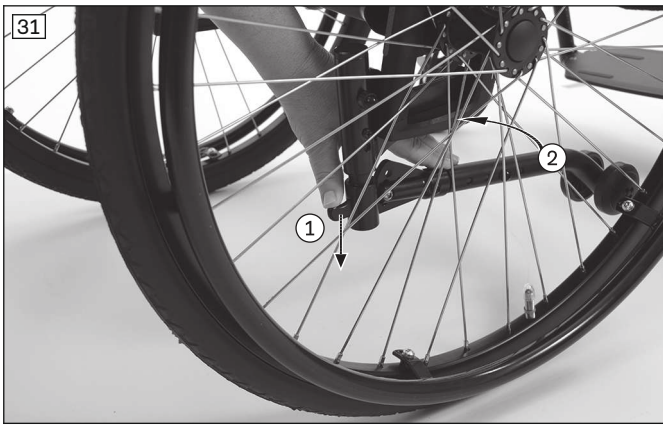

7.11.2 Using the tip-assist

- 1) At an obstacle, place one foot on the tip-assist and push down (see fig. 35).
- 2) The wheelchair can be tipped easily by simultaneously pressing down on the push handles.



7.12 Lap belt (seat belt)

⚠ CAUTION

Incorrectly adjusted lap belt

Malpositions, illness, falling of the user due to installation/adjustment errors

- ▶ Do not modify the settings established by the qualified personnel. In case of problems with the adjustments (unsatisfactory sitting position) please contact the qualified personnel who fitted the product.
- ▶ The lap belt has to fit closely but not too tightly so the user is not injured. It should be possible to slide two fingers comfortably between the belt and thigh.
- ▶ Have the settings of the belt system checked regularly. Adjustments may be required due to the growth of the user or because of changes in the course of the disease or different clothing.

The lap belt (seat belt) prevents the user from slipping and supports positioning.

It is installed on the product by qualified personnel if needed and adapted to the requirements of the user. Information about subsequent acquisition and mounting is provided by the qualified personnel that handed over the product.

Using the lap belt

- 1) Open the buckle.
- 2) Place the user in an upright, 90° seated position (if physiologically possible). Ensure that the back is up against the back support pad (if physiologically possible).
- 3) Close the buckle.
- 4) The lap belt should be at an angle of about **60°** to the seat bottom. The belt strap should run across the thighs in front of the pelvic bones (see fig. 36).

Possible errors

- The lap belt is positioned above the user's pelvis in the area of the soft part of the stomach.
- The user does not sit upright in the seat.
- If the lap belt is too loose, the user can shift/slide out to the front.
- During the installation/adjustment, the lap belt is routed over parts of the seating system (e.g. over forearm supports or seat pads). This causes the lap belt to lose its retaining function.

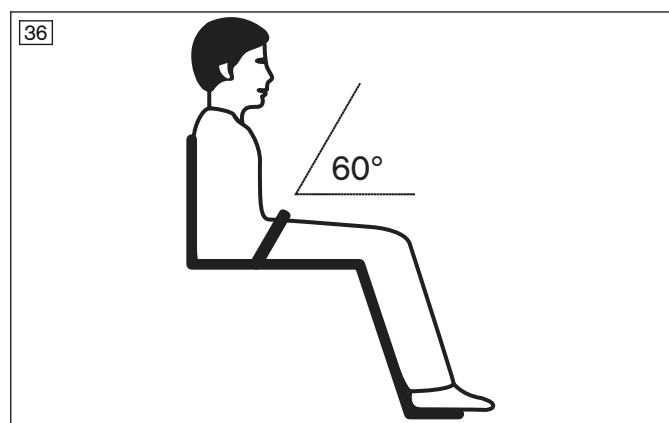

7.13 Additional options

The product may be equipped with additional options.

The options are firmly mounted to the product by qualified personnel or the manufacturer and are pre-adjusted by qualified personnel at delivery.

7.14 Disassembly and transport

⚠ CAUTION

Exposed pinch points

Crushing, pinching due to incorrect handling

- ▶ When folding the wheelchair out or together, only grip by the specified components.

NOTICE

Deformation when folded

Damage to the product, problems unfolding due to unallowable loads

- ▶ Never place heavy objects on the folded product.

INFORMATION

The disassembly described below may also be carried out the same way on the CLT model (not illustrated). The "Folding back support" option is not offered for the Zenit CLT.

The wheelchair must be prepared for transport in a passenger vehicle.

Zenit; Zenit CLT – folding version

- 1) Apply the wheel lock.

- 2) Remove the seat cushion.
 - 3) **Only with the “Folding back support” option:** Pull the release strap for the folding mechanism of the back support upwards (see fig. 37) and fold the back support down (see fig. 38).
Only with “Leg support with unlocking” option: Press down the lock button on the foot plate and fold the unlocked foot plate up (see Page 18).
 - 4) Pull the release strap for the folding mechanism (see fig. 39).
 - 5) Fold the wheelchair (see fig. 40).
 - 6) Fasten the safety strap (see fig. 41).
 - 7) Reach between the spokes of the drive wheel with your fingers and press the knob of the quick-release axle with your thumb. Pull off the drive wheel outwards (see fig. 6).
- INFORMATION: For the “lock-release assist” option, see the section “Drive wheels”.**



Zenit R; Zenit R CLT – rigid frame version

- 1) Apply the wheel lock.
- 2) Remove the seat cushion.

- 3) **Only with the “Folding back support” option:** Pull the release strap for the folding mechanism of the back support upwards (see fig. 37) and fold the back support down (see fig. 38).
- 4) Reach between the spokes of the drive wheel with your fingers and press the knob of the quick-release axle with your thumb. Pull off the drive wheel outwards (see fig. 6).
- INFORMATION: For the “lock-release assist” option, see the section “Drive wheels”.**

7.15 Use in vehicles for transporting persons with reduced mobility

7.15.1 Zenit, Zenit R without CLT option

⚠ WARNING

Use in vehicles for transporting persons with reduced mobility

Serious injuries in case of accidents due to user error

- ▶ Always use the seats and personal restraint systems in the vehicle for transporting persons with reduced mobility first. This is the only way to ensure optimum protection of passengers in the event of an accident.
- ▶ If the product is to be used as a seat in a vehicle for transporting persons with reduced mobility, the safety elements offered by the manufacturer and appropriate fastening and personal restraint systems must be used. For more information, please refer to our brochure with the order number 646D158.
- ▶ Never transport more than one person in the product.
- ▶ Only use the product in a vehicle for transporting persons with reduced mobility with the back support in a vertical position.
- ▶ Observe the limitations regarding installed options (see Page 33).

⚠ WARNING

Use of the belt system as a passenger restraint system in vehicles for transporting persons with reduced mobility is forbidden

Serious injuries due to improper handling of the product

- ▶ Under no circumstances may the belts and positioning aids offered with the product be used as part of a passenger restraint system in vehicles for transporting persons with reduced mobility.
- ▶ Note that the belts and positioning aids offered with the product are only intended to help support the user sitting in the product.

⚠ WARNING

Prohibited transportation of the passenger with activated back angle adjustment

Loss of safe restraint in the product due to user error

- ▶ Ensure the passenger is seated in a nearly upright position during transport.
- ▶ If a back angle adjustment mechanism is installed, move the backrest to a nearly upright position prior to travel.
- ▶ Check the locking mechanism on both sides.

The product has been tested by the manufacturer according to ISO 7176-19 and may be used as a seat in vehicles for transporting persons with reduced mobility subject to the conditions defined below.

The product must be sufficiently secured during transport in vehicles for transporting persons with reduced mobility. The illustrations that follow show an example for anchoring in a motor vehicle.

The manufacturer is not responsible for the fastening systems that are used. Ensure that only fastening systems that meet the applicable legal requirements and are designed for the overall weight of the product including the user are used.

The transport weight of the person to be transported in a vehicle for transporting persons with reduced mobility corresponds to the maximum permissible user weight (see Page 38).

7.15.1.1 Required accessories

To use the product as a seat in a vehicle for transporting persons with reduced mobility, additional accessories have to be mounted:

- Zenit, Zenit R: 481S160=SK010 anchor point kit (2x tension strap, 4x S-hook)
- The following accessories are required, but not included in the 481S160=SK010 anchor point kit: four belt loops (e.g. from the manufacturers Q'STRAIT or Unwin Safety Systems, tested according to ISO 10542-1)

The qualified personnel who fitted the wheelchair can provide more information about accessories.

7.15.1.2 Installation

Checking suitability of the wheelchair configuration for a vehicle for transporting persons with reduced mobility

Before installing the anchor point kit, check whether the product in the supplied configuration is suitable for use in a vehicle for transporting persons with reduced mobility. This is indicated by the specific version of the side supports. Since the required belt loops always have to be wrapped around the side support at the highest possible position (opening), this opening must not be too narrow for the belt loops to pass through (see fig. 42, item 1). Otherwise the product may not be used in vehicles for transporting persons with reduced mobility.

Installing the tension straps (front)

Attaching the tension straps is mandatory prior to use in a vehicle for transporting persons with reduced mobility:

- 1) Engage the hooks of the previously slackened and slightly loosened tension straps, with the buckle closed, between the caster attachment device and drive wheel adapter and tighten them (see fig. 43, item 1).
- 2) By pushing the press button on the buckle (see fig. 43, item 2), the straps can be opened or loosened again for removal after use.

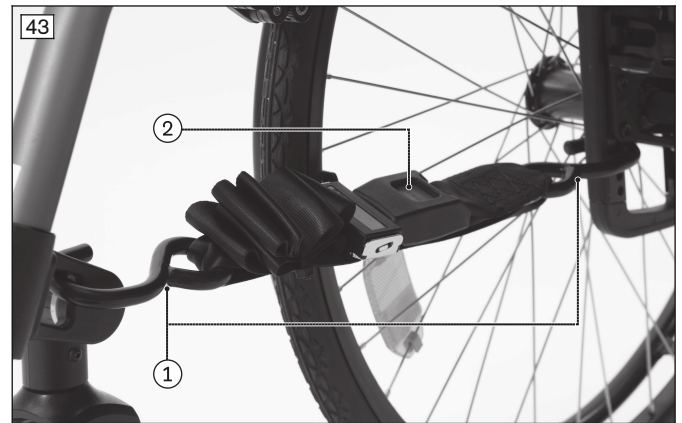

7.15.1.3 Using the product in a vehicle

⚠ WARNING

Positioning in vehicles for transporting persons with reduced mobility

Serious injuries in case of accidents due to user error

- ▶ Positioning of the product in vehicles for transporting persons with reduced mobility may only be performed by the qualified personnel.
- ▶ The product must always face forwards when it is used as a seat in a vehicle for transporting persons with reduced mobility.
- ▶ Instruct the qualified personnel regarding the mounting points on your product described below.

⚠ WARNING

Inadequate transportation safety

Loss of safe restraint due to failure to observe transportation instructions

- ▶ Observe the following instructions for correct transport safety in the vehicle for transporting persons with reduced mobility.
- ▶ If necessary, instruct the qualified personnel on the following information.

Securing the product in the vehicle for transporting persons with reduced mobility

The wheelchair is secured in the vehicle for transporting persons with reduced mobility with the help of four belt loops, on which the vehicle side wheelchair restraint belts are attached.

The fixation points of the belt loops are marked with stickers (pattern). These stickers show where the user has to pass the belt loops around the frame tube:

- The stickers that label the front fixation points are found above the caster attachment device on each side: see fig. 44, item 1.
- The stickers that label the rear fixation points are found above the folding mechanism (Zenit) or above the rigid axle (Zenit R) on each side: see fig. 45, item 1.

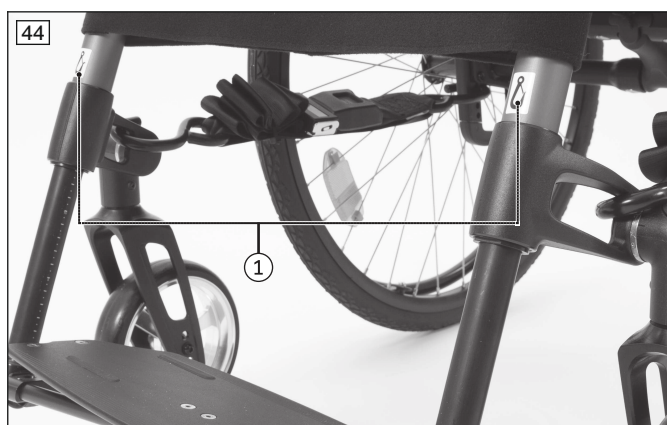

Attaching the belt loops

- 1) Position the product in the vehicle for transporting persons with reduced mobility. For more information, please refer to section 5 in the brochure "Transporting persons with reduced mobility", order number 646D158.
 - 2) **Front fixation points:** Attach one belt loop around each of the frame tubes on the left and right of the front frame, wrapping them around the frame tubes at the marked position once or twice depending on the length (see fig. 46, item 1).
 - 3) Engage the hook of the respective vehicle side wheelchair restraint belt in the belt loop (see fig. 46, item 2).
 - 4) **Rear fixation points:** Attach one belt loop around the side supports on the left and right sides above the folding mechanism (Zenit) or above the rigid axle (Zenit R) (see fig. 47, item 1).
- CAUTION! Note that the belt loops always have to be wrapped around the side supports at the highest possible position (opening) (see fig. 42).**
- 5) Engage the hook of the respective vehicle side wheelchair restraint belt in the belt loop (see fig. 47, item 2).
 - 6) Tighten the vehicle side wheelchair restraint belts at the front and rear as firmly as possible.
→ The product showing the correct positioning of the attachment straps (see fig. 49).

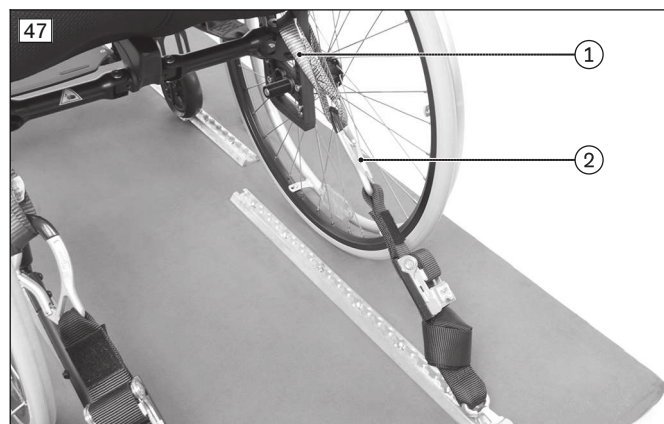
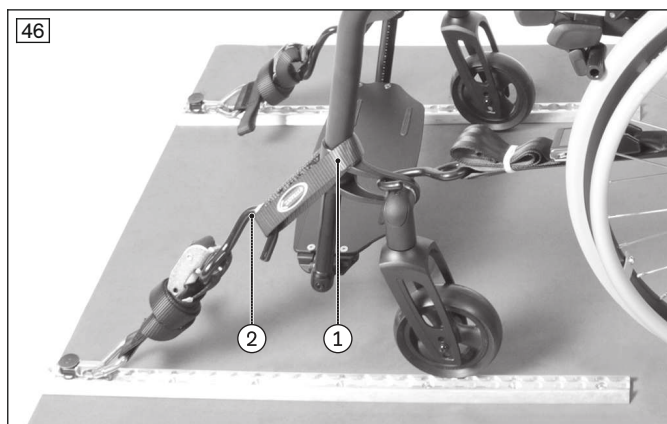

Information on correct transport safety of the user in the vehicle for transporting persons with reduced mobility

- Using the personal restraint system of the vehicle for transporting persons with reduced mobility is required. Attaching personal restraint systems of the vehicle for transporting persons with reduced mobility to the wheelchair is not permitted. The 3-point restraint has to be realised entirely on the vehicle:
 - The lap belt of the personal restraint system is usually attached by the qualified personnel to the left and right sides respectively on the mounting point/pin of the rear lashing straps (wheelchair restraint belts on the vehicle bottom).
 - The shoulder belt of the personal restraint system is usually mounted on the vehicle pillar and is attached by the qualified personnel to the corresponding mounting point/pin provided on the lap belt.
- The straps of the personal restraint system must always be routed close to the user's body. The straps must not be routed over the side panels and wheels (see fig. 48 item 2).
- The shoulder belt must always be routed over the user's shoulder (see fig. 48, item 1).
- The belt strap must not be twisted on the user's body.

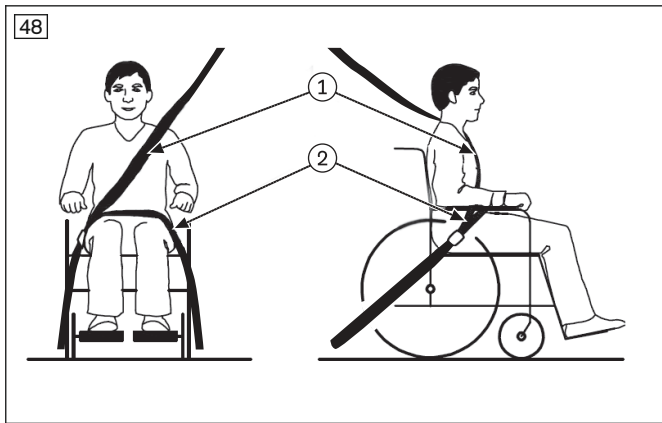

Placement of the personal restraint system integrated in the vehicle for transporting persons with reduced mobility

- 1) Pull the respective ends of the restraint lap belt from the inner side of the seat through to the outside. (see fig. 50).
- 2) Engage the ends of the restraint lap belt on the mounting point/pin of the rear lashing straps on the left and right sides respectively (see fig. 51).
Alternatively, the end of the restraint lap belt can also be attached on the bottom of the vehicle for transporting persons with reduced mobility with the help of a belt reel or retractor (seat belt tightener).
- 3) Secure the shoulder harness on the mounting point/pin provided on the lap belt (not illustrated).
→ The restraint lap belt is pulled through and fastened.
→ The belt runs between the side panel and seat cushion on each side.



7.15.1.4 Restrictions for use

⚠ WARNING

Risk of accidents and injury due to using the product with certain settings and/or installed options

Severe injury in case of accidents due to options coming loose

- ▶ Before using the product as a seat in a vehicle for transporting persons with reduced mobility, remove options that need to be taken off for safe transportation. Please observe the following table.
- ▶ Stow all dismantled components securely in the vehicle for transporting persons with reduced mobility.
- ▶ Please note that certain settings on the product exclude the use of the product in a vehicle for transporting persons with reduced mobility.

INFORMATION

Note that attaching the belt loops in the side supports is not always possible due to the chosen product configuration. In this case, the product may not be used in vehicles for transporting persons with reduced mobility. Observe the corresponding notices in the previous section.

Option ¹⁾	Transportation in a vehicle for transporting persons with reduced mobility not possible	Remove option	Secure option on product
Clinical mounting kit		X	
Head support		X	
Lap belt			X ²⁾

¹⁾ Not all of the options named are installed on all products.

²⁾ The belt can be used to position the passenger during transportation. Using the personal restraint system is nevertheless required.

7.15.2 Zenit CLT, Zenit R CLT Option

⚠ WARNING

Improper use in vehicles for transporting persons with reduced mobility

Risk of serious injury when using the product as a seat

- ▶ The product has **not** been approved by the manufacturer for use as a seat in vehicles for transporting persons with reduced mobility.
- ▶ In vehicles for transporting persons with reduced mobility, only use the seats installed in the vehicle with the corresponding personal restraint systems.
- ▶ Information on the current status of our measures is available from the qualified personnel.

The Zenit CLT and Zenit CLT R wheelchairs have not been approved by the manufacturer for use as a seat in a vehicle for transporting persons with reduced mobility.

7.16 Care

⚠ CAUTION

Lack of or improper cleaning

Health hazard due to infections, damage to the product due to user error

- ▶ Clean the product at regular intervals.
- ▶ Do not clean the product with a jet of water or a pressure washer. The penetration of water can cause corrosion and subsequent malfunctions.
- ▶ To avoid contamination with germs, clean seat cushions and back support upholstery whenever they get soiled.
- ▶ Check the driving behaviour of the product after cleaning it.

7.16.1 Cleaning

Clean the product regularly depending on the degree of soiling and frequency of use, **at least 1x per month**:

7.16.1.1 Cleaning by hand

- 1) Clean the padding and upholstery with warm water and a mild detergent.

- 2) Remove any spots with a sponge or a soft brush.
- 3) Rinse with clear water and let the components dry.

Important information on cleaning

- Clean plastic parts, frame parts and the chassis and wheels with a mild cleaner and a damp cloth. Dry thoroughly afterwards.
- Do not use any aggressive cleaners, solvents or hard brushes etc.
- Do not spray the product with a pressure washer.

7.16.1.2 Cleaning the seat cushion

Standard seat cushion

- ▶ Clean the seat cushion according to the attached care label.

Seat cushion with foam core

- 1) Open the zipper and remove the foam core (see fig. 52).
- 2) Clean the cover according to the attached care label.
- 3) Wash all foam parts by hand at **40°C** using a mild, environmentally friendly detergent. Allow to air dry.
- 4) Reinsert the foam core with proper alignment. Close the zipper.



Important information on cleaning

- For more information on cleaning seat cushions, see the care instructions on the product or the supplied instructions for use.

7.16.1.3 Cleaning belts/straps

Cleaning a belt system with metal closure

INFORMATION

Observe the washing recommendations on the product and the information in the corresponding instructions for use provided for the product.

- Straps with metal closures **may not be washed in the washing machine** as the penetration of water could cause corrosion and subsequent malfunctions.
- Clean the belt straps by gently dabbing them with warm soapy water (with some disinfectant) or carefully wipe with a dry, clean, absorbent cloth.

Additional cleaning instructions

- Allow the belts to air dry. Ensure that the belts and pads are completely dry before installation.
- Do not expose the belts to direct heat (e.g. sunshine, stove or radiator).
- Do not iron or bleach the belts.

7.16.2 Disinfection

- 1) Thoroughly clean the pads and handles before disinfecting.
- 2) Wipe all parts of the wheelchair with a disinfectant.

Important information about disinfecting

- If the product is used by more than one person, using a conventional disinfectant is required.

- Only use colourless water-based disinfectants. Observe the instructions for use provided by the manufacturer.

8 Maintenance and repair

8.1 Maintenance

WARNING

Insufficient maintenance

Severe user injuries, damage to the product due to failure to observe maintenance intervals

- ▶ Only carry out the maintenance tasks described in this section. All other maintenance and service tasks may only be carried out by qualified personnel.
- ▶ The functionality and operating safety of the product must be verified and a service performed at least **once per year**.
- ▶ For users with a changing anatomy (for example body dimensions, weight) or users with a changing clinical picture, have the product inspected, adjusted and serviced at least **once every six months**.

- The function of the product should be checked **before each use**.
- The product may not be used if defects are noted. This applies in particular in case of instability of the product or altered driving characteristics as well as problems with the user's seating position or the stability of the seat. Inform the qualified personnel promptly for the rectification of defects.
- This also applies if loose, worn, bent or damaged components, cracks in the frame or broken frame components are identified.
- Some maintenance tasks can be carried out to a certain extent by the user at home (see the sections "Maintenance intervals" and "Maintenance tasks").
- Failure to maintain the product can lead to injuries for the user of the product.

8.1.1 Maintenance intervals

The functions described below must be checked by the user or an attendant at the specified intervals:

Inspection task	Before each use	Monthly	Quarterly
Functional test of the wheel locks	X		
Sagging of the seat or back upholstery		X	
Stability of the legrests		X	
Visual inspection of wear and tear parts (e.g., tyres, bearings)		X	
Soiling of bearings		X	
Damage to the handrim		X	
Air pressure (information see tyre sidewall)		X	
Wear and tear of the folding device		X	
Check of the spoke tension on the drive wheels			X
Check of all bolted connections			X
Check the legibility of all labels and markings on the product		X	

8.1.2 Maintenance tasks

To ensure smooth operation at all times, users or attendants with some technical skills can maintain some parts of the product:

- Screw connections must be periodically checked for tightness, especially during the initial period of use or after adjustments have been made to the wheelchair. If a screw connection loosens repeatedly, contact the qualified personnel promptly.
- Particles of dirt and hair accumulate on the caster wheel axle and threaded axle of the caster fork over time. This makes the steering stiffer. Regularly remove dirt and oil the axles. See the section "Approach in case of stiffness".
- The drive wheels are equipped with a quick-release axle system as standard equipment. To keep this system operational, ensure that no dirt adheres to the quick-release axle or receiver bushing. Periodically lubricate the quick-release axle lightly with thin, resin-free oil (sewing machine oil).
- If the wheelchair becomes wet, it should be rubbed dry again.

8.2 Repair

⚠ WARNING

Prohibited repairs

Severe user injuries, damage to the product due to adjustment and installation errors

- ▶ Only carry out the repairs described in this section. All other repairs may only be carried out by the qualified personnel.

8.2.1 Inner tube, rim tape and tyre replacement

⚠ CAUTION

Improper tyre replacement

Injuries to the user due to incorrect installation, product damage

- ▶ No person is permitted to sit in the wheelchair during tyre replacement
- ▶ Before removing a wheel, support the product so it cannot tip over.
- ▶ Always replace the tyres in pairs. Two differently worn tyres affect the directional stability of the wheelchair.

INFORMATION

When driving outdoors, always carry a repair kit and tyre pump (when using pneumatic tyres) in case of emergency.

Suitable tyre pumps are listed on the order form and are supplied with the product. An alternative is tyre foam, which fills your tyre and then hardens (available from bicycle shops, etc.).

Repairing flat tyres requires only the necessary tools and users may change tyres themselves if they wish:

Removal and preparing for installation

- 1) Carefully remove the tyre from the rim using appropriate tools.
INFORMATION: Take care not to damage the rim or the inner tube.
- 2) Unscrew the valve nut from the valve and remove the tube.
- 3) Repair the tube according to the directions in the repair kit or replace it with a new tube.
- 4) Before fitting the tyre again, inspect the rim bed and tyre inner wall for foreign objects. This could have caused the puncture.
- 5) Before installing the tube, check that the rim band is in proper condition. The rim band protects the tube from being damaged by the ends of the spokes.



Replacing the rim band (only when necessary)

- 1) If the rim band needs to be replaced, remove it from the rim.
- 2) Install the new rim band on the inside of the rim, making sure the valve opening is in the right position.
- 3) Glue the rim band in place if this is intended. Ensure that all spoke ends are covered.

Installing the tube and tyre

- 1) Behind the valve, push one side of the tyre over the edge of the rim.
- 2) Slightly inflate the tube until it starts to assume its round shape.
- 3) Unscrew the valve nut from the tube and push the valve through the valve opening in the rim.

- 4) Insert the tube into the tyre.
- 5) Mount the other side of the tyre on the rim, starting from the position across the valve. Ensure that the tube is not pinched between the tyre and rim during this process.



Inflating the tube

- 1) Ensure that the valve is positioned perpendicularly for proper positioning of the tube and tyre in the region of the valve.
- 2) Firmly screw on the valve nut.
- 3) Inflate the tube so that the tyre can still be pressed in easily with your thumb.
INFORMATION: If the circumferential lines on the two sides of the tyre are both at an even distance from the rim, the tyre is centred. If not, let some air out and realign the tyre.
- 4) Inflate the tube to the maximum pressure specified by the tyre manufacturer (see information printed on the tyre sidewall).
- 5) Firmly screw the valve cap onto the valve.

9 Disposal

9.1 Disposal information

Return the product to the qualified personnel for disposal.

All components of the product must be disposed of properly in accordance with the respective national environmental regulations.

10 Legal information

All legal conditions are subject to the respective national laws of the country of use and may vary accordingly.

10.1 Liability

The manufacturer will only assume liability if the product is used in accordance with the descriptions and instructions provided in this document. The manufacturer will not assume liability for damage caused by disregarding the information in this document, particularly due to improper use or unauthorised modification of the product.

10.2 Warranty

Further information on the warranty terms and conditions can be obtained from the qualified personnel that has fitted this product or the manufacturer's service (see inside back cover for addresses).

10.3 Service life

Expected lifetime: **4 years**

The design, manufacturing and requirements for the intended use of the product are based on the expected lifetime. These also include the requirements for maintenance, ensuring effectiveness and the safety of the product.

11 Technical data

INFORMATION

- ▶ Much of the technical data below is given in mm. Please note that product settings – unless otherwise specified – cannot be adjusted in the mm range but only in increments of approx. **0.5 cm** or **1 cm**.
- ▶ Note that the values achieved during adjustment may deviate from the values specified below. The deviation can be **±10 mm** and **±2°**.

Zenit; Zenit R – general information

	Zenit; Zenit R
Max. load [kg]	120 ¹⁾
Weight [kg]	Zenit: from approx. 8.9 ²⁾ Zenit R: from approx. 7.4 ²⁾
Transport weights [kg] (for seat width of 440 mm)	Frame: 6.5 ²⁾ Drive wheel, 24": 1.3 ²⁾
Seat width [mm]	320–460
Front seat height [mm]	380–540
Rear seat height [mm]	370–500
Seat depth [mm]	360–500
Overall length [mm]	640–1040
Overall width [mm]	495–710
Overall height [mm]	620–1,050
Height, folded [mm]	580–740
Folding size [mm]	330 ³⁾
Back support angle [°]	-10–+10
Back support height [mm]	250–500
Lower leg length [mm]	280–510
Angle leg support to seat bottom [°]	0–15
Distance from arm support to seat [mm]	250–330
Positioning of the arm support [mm]	170–260
Horizontal axle position [mm]	50–140
Anterior frame angle [°]	75–85
Drive wheels	24", 25"
Caster wheels	4", 5", 5.5", 6"
Permissible tyre type	Pneumatic, PU or solid rubber / 1", 1 3/8"
Min. tyre pressure [bar]	7 ⁴⁾
Minimum turning radius [mm] ⁵⁾	480–680
Handrim diameter [mm]	470–560
Maximum permissible inclination [°]/[%] ⁶⁾⁷⁾⁸⁾	7/12.3

¹⁾ Depending on selected option: 100 kg/120 kg. See nameplate for exact information.

²⁾ The specified weights vary according to the selected options and model.

³⁾ Does not apply for Zenit R and Zenit R CLT.

⁴⁾ Varies according to tyre option; see the marking on the tyre wall.

⁵⁾ In accordance with ISO 7176-5.

⁶⁾ Also applies for parking with wheel lock engaged.

⁷⁾ Applies to all directions (upwards, downwards, sideways).

⁸⁾ In accordance with ISO 7176-1.

Ambient conditions

Temperatures and relative humidity	
Temperature during use [°C (°F)]	-10 to +40 (14 to 104)
Transport and storage temperature [°C (°F)]	-10 to +40 (14 to 104)

Temperatures and relative humidity	
Relative humidity [%]	45 to 85; non-condensing

12 Appendices

12.1 Threshold values for wheelchairs transportable by train

INFORMATION

- ▶ The products in this series fully satisfy the minimum technical requirements of regulation (EU) No. 1300/2014 regarding train accessibility for people with disabilities. However, not all versions can comply with all threshold values due to different settings.
- ▶ With the help of the table that follows, you or the qualified personnel can take measurements and verify whether the specific product in question meets the threshold values.

Feature	Threshold value (according to Directive (EU) No. 1300/2014)
Length [mm]	1200 (plus 50 mm for the feet)
Width [mm]	700 (plus 50 mm on each side for the hands when moving)
Smallest wheels ["]	approx. 3 or greater (according to the directive, the smallest wheel must be able to overcome a gap measuring 75 mm horizontally and 50 mm vertically)
Height [mm]	max. 1375; including a 1.84 m large male wheelchair user (95th percentile)
Turning radius [mm]	1500
Maximum weight [kg]	200 (for wheelchair and user, including any baggage)
Maximum obstacle height that can be overcome [mm]	50
Ground clearance [mm]	60 (at an upward slope angle of 10°, ground clearance must measure at least 60 mm under the footrest for going forward at the end of the slope)
Maximum inclination angle on which the wheelchair will remain stable [°]	6 (dynamic stability in all directions) 9 (static stability in all directions, also when wheel lock engaged)



A series of horizontal lines spanning the width of the page, providing a template for writing. The lines are evenly spaced and extend from the left margin to the right margin.

Kundenservice/Customer Service

Europe

Otto Bock HealthCare Deutschland GmbH
Max-Näder-Str. 15 · 37115 Duderstadt · Germany
T +49 5527 848-3433 · F +49 5527 848-1460
healthcare@ottobock.de · www.ottobock.de

Otto Bock Healthcare Products GmbH
Brehmstraße 16 · 1110 Wien · Austria
F +43 1 5267985
service-admin.vienna@ottobock.com · www.ottobock.at

Otto Bock Adria d.o.o. Sarajevo
Ramiza Salčina 85
71000 Sarajevo · Bosnia-Herzegovina
T +387 33 255-405 · F +387 33 255-401
obadria@bih.net.ba · www.ottobockadria.com.ba

Otto Bock Bulgaria Ltd.
41 Tzar Boris III Blvd. · 1612 Sofia · Bulgaria
T +359 2 80 57 980 · F +359 2 80 57 982
info@ottobock.bg · www.ottobock.bg

Otto Bock Suisse AG
Luzerner Kantonsspital 10 · 6000 Luzern 16 · Suisse
T +41 41 455 61 71 · F +41 41 455 61 70
suisse@ottobock.com · www.ottobock.ch

Otto Bock ČR s.r.o.
Protetická 460 · 33008 Zruč-Senec · Czech Republic
T +420 377825044 · F +420 377825036
email@ottobock.cz · www.ottobock.cz

Otto Bock Iberica S.A.
C/Majada, 1 · 28760 Tres Cantos (Madrid) · Spain
T +34 91 8063000 · F +34 91 8060415
info@ottobock.es · www.ottobock.es

Otto Bock France SNC
4 rue de la Réunion · CS 90011
91978 Courtaboeuf Cedex · France
T +33 1 69188830 · F +33 1 69071802
information@ottobock.fr · www.ottobock.fr

Otto Bock Healthcare plc
32, Parsonage Road · Englefield Green
Egham, Surrey TW20 0LD · United Kingdom
T +44 1784 744900 · F +44 1784 744901
bockuk@ottobock.com · www.ottobock.co.uk

Otto Bock Hungária Kft.
Tatai út 74. · 1135 Budapest · Hungary
T +36 1 4511020 · F +36 1 4511021
info@ottobock.hu · www.ottobock.hu

Otto Bock Adria d.o.o.
Dr. Franje Tuđmana 14 · 10431 Sveta Nedelja · Croatia
T +385 1 3361 544 · F +385 1 3365 986
ottobockadria@ottobock.hr · www.ottobock.hr

Otto Bock Italia Srl Us
Via Filippo Turati 5/7 · 40054 Budrio (BO) · Italy
T +39 051 692-4711 · F +39 051 692-4720
info.italia@ottobock.com · www.ottobock.it

Otto Bock Benelux B.V.
Mandenmaker 14 · 5253 RC
Nieuwkuijk · The Netherlands
T +31 73 5186488 · F +31 73 5114960
info.benelux@ottobock.com · www.ottobock.nl

Industria Ortopédica Otto Bock Unip. Ltda.
Av. Miguel Bombarda, 21 - 2º Esq.
1050-161 Lisboa · Portugal
T +351 21 3535587 · F +351 21 3535590
ottobockportugal@mail.telepac.pt

Otto Bock Polska Sp. z o. o.
Ulica Koralowa 3 · 61-029 Poznań · Poland
T +48 61 6538250 · F +48 61 6538031
ottobock@ottobock.pl · www.ottobock.pl

Otto Bock Romania srl
Șos de Centura Chitila - Mogoșoaia Nr. 3
077405 Chitila, Jud. Ilfov · Romania
T +40 21 4363110 · F +40 21 4363023
info@ottobock.ro · www.ottobock.ro

OOO Otto Bock Service
p/o Pultikovo, Business Park „Greenwood”,
Building 7, 69 km MKAD
143441 Moscow Region/Krasnogorskiy Rayon
Russian Federation
T +7 495 564 8360 · F +7 495 564 8363
info@ottobock.ru · www.ottobock.ru

Otto Bock Scandinavia AB
Koppargatan 3 · Box 623 · 60114 Norrköping · Sweden
T +46 11 280600 · F +46 11 312005
info@ottobock.se · www.ottobock.se

Otto Bock Slovakia s.r.o.
Röntgenova 26 · 851 01 Bratislava 5 · Slovak Republic
T +421 2 32 78 20 70 · F +421 2 32 78 20 89
info@ottobock.sk · www.ottobock.sk

Otto Bock Sava d.o.o.
Industrijska bb · 34000 Kragujevac · Republika Srbija
T +381 34 351 671 · F +381 34 351 671
info@ottobock.rs · www.ottobock.rs

Otto Bock Ortopedi ve
Rehabilitasyon Tekniği Ltd. Şti.
Mecidiyeköy Mah. Lati Lokum Sok.
Meriç Sitesi B Blok No: 30/B
34387 Mecidiyeköy-Istanbul · Turkey
T +90 212 3565040 · F +90 212 3566688
info@ottobock.com.tr · www.ottobock.com.tr

Africa

Otto Bock Algérie E.U.R.L.
32, rue Ahcène Outaleb - Coopérative les Mimosas
Mackle-Ben Aknoun · Alger · DZ Algérie
T +213 21 913863 · F +213 21 913863
information@ottobock.fr · www.ottobock.fr

Otto Bock Egypt S.A.E.
28 Soliman Abaza St. Mohandessein · Giza · Egypt
T +20 2 37606818 · F +20 2 37605734
info@ottobock.com.eg · www.ottobock.com.eg

Otto Bock South Africa (Pty) Ltd
Building 3 Thornhill Office Park · 94 Bekker Road
Midrand · Johannesburg · South Africa
T +27 11 564 9360
info-southafrica@ottobock.co.za
www.ottobock.co.za

Americas

Otto Bock Argentina S.A.
Av. Belgrano 1477 · CP 1093
Ciudad Autónoma de Buenos Aires · Argentina
T +54 11 5032-8201 / 5032-8202
atencionclientes@ottobock.com.ar
www.ottobock.com.ar

Otto Bock do Brasil Tecnica Ortopédica Ltda.
Alameda Maria Tereza, 4036, Bairro Dois Córregos
CEP: 13.278-181, Valinhos-São Paulo · Brasil
T +55 19 3729 3500 · F +55 19 3269 6061
ottobock@ottobock.com.br · www.ottobock.com.br

Otto Bock HealthCare Canada
5470 Harvester Road
Burlington, Ontario, L7L 5N5, Canada
T +1 800 665 3327 · F +1 800 463 3659
CACustomerService@ottobock.com
www.ottobock.ca

Oficina Ottobock Habana
Calle 3ra entre 78 y 80.
Edificio Jerusalem · Oficina 112 · Calle 3ra.
Playa, La Habana. Cuba
T +53 720 430 69 · +53 720 430 81
hector.corcho@ottobock.com.br
www.ottobock.com.br

Otto Bock HealthCare Andina Ltda.
Calle 138 No 53-38 · Bogotá · Colombia
T +57 1 8619988 · F +57 1 8619977
info@ottobock.com.co · www.ottobock.com.co

Otto Bock de Mexico S.A. de C.V.
Prolongación Calle 18 No. 178-A
Col. San Pedro de los Pinos
C.P. 01180 México, D.F. · Mexico
T +52 55 5575 0290 · F +52 55 5575 0234
info@ottobock.com.mx · www.ottobock.com.mx

Otto Bock HealthCare LP
11501 Alterra Parkway Suite 600
Austin, TX 78758 · USA
T +1 800 328 4058 · F +1 800 962 2549
USCustomerService@ottobock.com
www.ottobockus.com

Asia/Pacific

Otto Bock Australia Pty. Ltd.
Suite 1.01, Century Corporate Centre
62 Norwest Boulevard
Baulkham Hills NSW 2153 · Australia
T +61 2 8818 2800 · F +61 2 8814 4500
healthcare@ottobock.com.au · www.ottobock.com.au

Beijing Otto Bock Orthopaedic Industries Co., Ltd.
B12E, Universal Business Park
10 Jiuxianqiao Road, Chao Yang District
Beijing, 100015, P.R. China
T +8610 8598 6880 · F +8610 8598 0040
news-service@ottobock.com.cn
www.ottobock.com.cn

Otto Bock Asia Pacific Ltd.
Unit 1004, 10/F, Greenfield Tower, Concordia Plaza
1 Science Museum Road, Tsim Sha Tsui
Kowloon, Hong Kong · China
T +852 2598 9772 · F +852 2598 7886
info@ottobock.com.hk · www.ottobock.com

Otto Bock HealthCare India Pvt. Ltd.
20th Floor, Express Towers
Nariman Point, Mumbai 400 021 · India
T +91 22 2274 5500 / 5501 / 5502
information@indiaottobock.com · www.ottobock.in

Otto Bock Japan K. K.
Yokogawa Building 8F, 4-4-44 Shibaura
Minato-ku, Tokyo, 108-0023 · Japan
T +81 3 3798-2111 · F +81 3 3798-2112
ottobock@ottobock.co.jp · www.ottobock.co.jp

Otto Bock Korea HealthCare Inc.
4F Agaworld Building · 1357-74, Seocho-dong
Seocho-ku, 137-070 Seoul · Korea
T +82 2 577-3831 · F +82 2 577-3828
info@ottobockkorea.com · www.ottobockkorea.com

Otto Bock South East Asia Co., Ltd.
1741 Phaholyothin Road
Kwaeng Chatuchark · Khet Chatuchark
Bangkok 10900 · Thailand
T +66 2 930 3030 · F +66 2 930 3311
obsea@ottobock.co.th · www.ottobock.co.th

Other countries

Ottobock SE & Co. KGaA
Max-Näder-Straße 15 · 37115 Duderstadt · Germany
T +49 5527 848-1590 · F +49 5527 848-1676
reha-export@ottobock.de · www.ottobock.com

Ihr Fachhändler | Your specialist dealer



Otto Bock Mobility Solutions GmbH
Lindenstraße 13 · 07426 Königsee/Germany
www.ottobock.com

